

## 7 Završni radovi

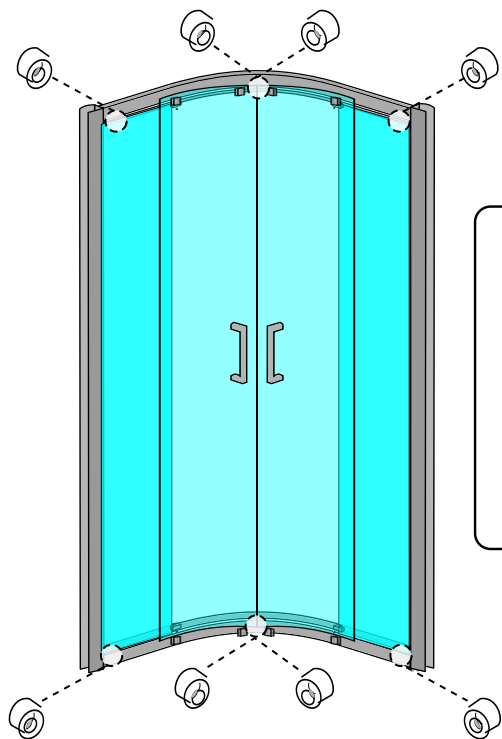

Nakon što su vrata nivelisana, na optimalne pozicije unutar vodilica vijcima 4,2x9,5 zavrnuti gumene graničnike (M) koji će zaustavljati vrata prilikom otvaranja ili zatvaranja.



Poslije montaže kabine sačekati 24 h prije prve upotrebe.



24 h



[www.hidrastil.ba](http://www.hidrastil.ba)

 **Hidra**  
Still

## Uputstvo za montažu

Tuš kabina Opal

MODEL: Opal 2V+2F  
(sk.17 u katalogu)

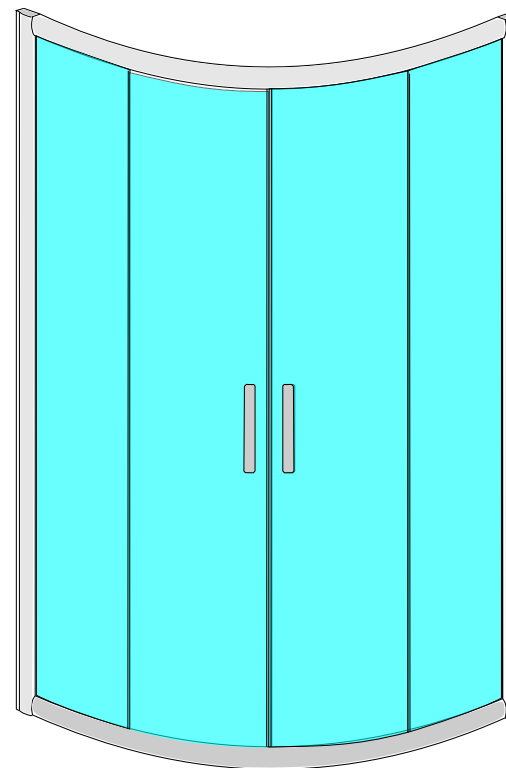

### MODELI

80x80 H183/H190

90x90 H183/H190

90x90 H160

120x80 H183

120x90 H183

100X100 H160

110X110 H150

\*\*\*

150X150 H150

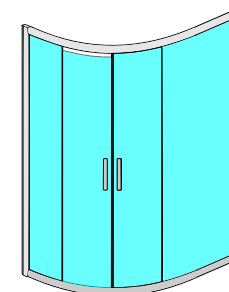

Iako je kvalitet materijala za kabine vrhunske kvalitete, može biti oštećen kako mehanički, tako i upotrebom određenih hemikalija (aceton i sl.). Takođe je moguće narušiti sjaj profila upotrebom abrazivnih sredstava.

U procesu ugradnje kabine preporučujemo da tuš, ako se na isti vrši montaža, zaštitite kartonom od mogućih oštećenja pri montaži kabine.

Proizvođač ne odgovara za štetu ili povredu osoba nastalih nepravilnom ugradnjom.



Brčko, BiH, tel: 049 590 470, fax: 049 590 473 [www.hidrastil.ba](http://www.hidrastil.ba)

# 1 Sastavni dijelovi - šema

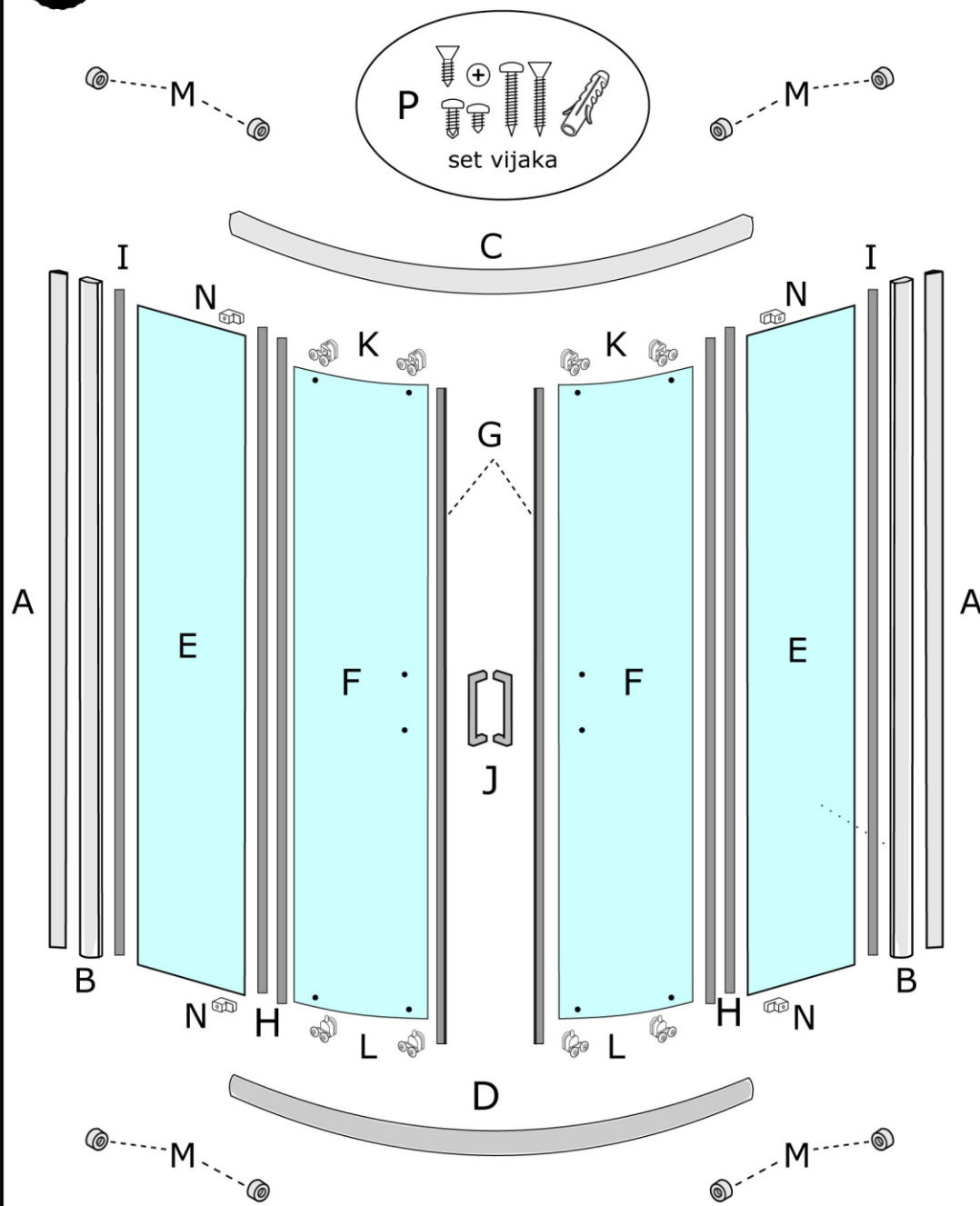

# 6 Završni radovi

Nakon što je okvir spojen i ubačen u zidne profile, pričvrstiti ih jedne za druge samoreznim vijcima 4,2x13.

Nanijeti tanki nanos silikona na mjesto gdje fiksno staklo naliježe na donju vodilicu.  
 Nakon toga, silikonirati spojeve okvira sa keramikom/tuš kadom.

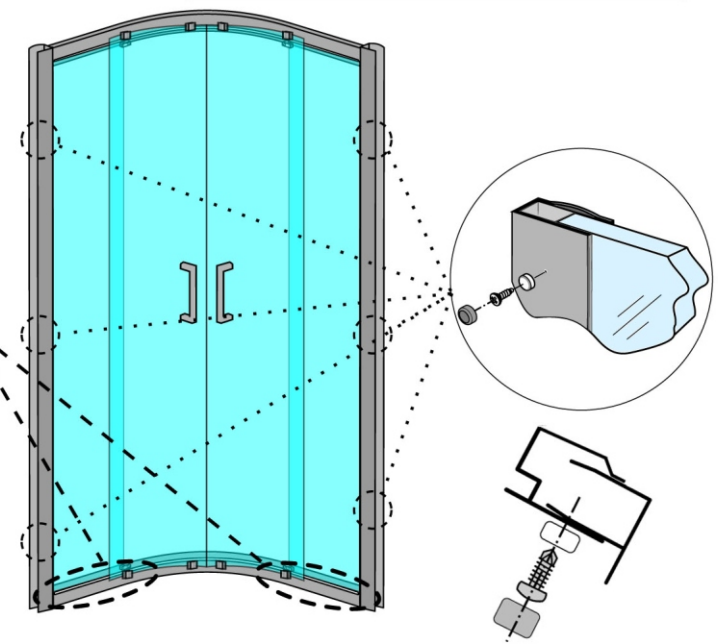
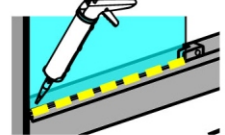

Postaviti magnetne (G) i F-brtve (H) kako je prikazano na skicama

Ako je potrebno dodatno nivelisati vrata, to se čini odvijanjem ili dotezanjem vijaka na gornjim točkicama.

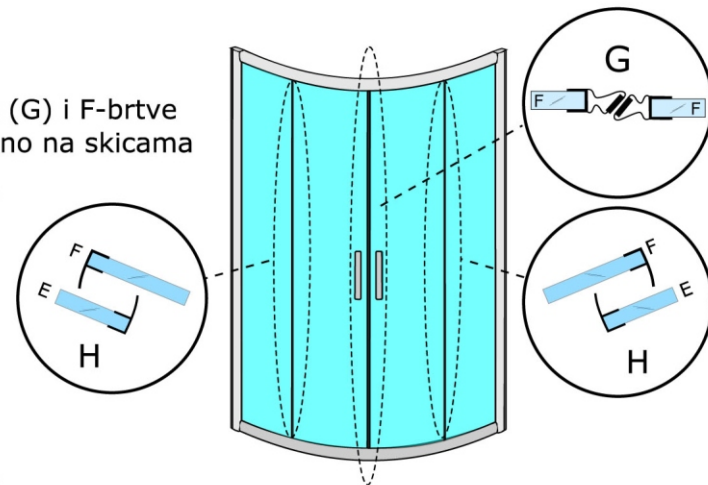

## 5 Montaža vrata

Postavljanje rukohvata (J), te gornjih (K) i donjih (L) točkića na vrata (F).



Donji točkići imaju "dugmić" čijim se pritiskom točkići spuštaju prilikom ubacivanja u donju vodilicu.

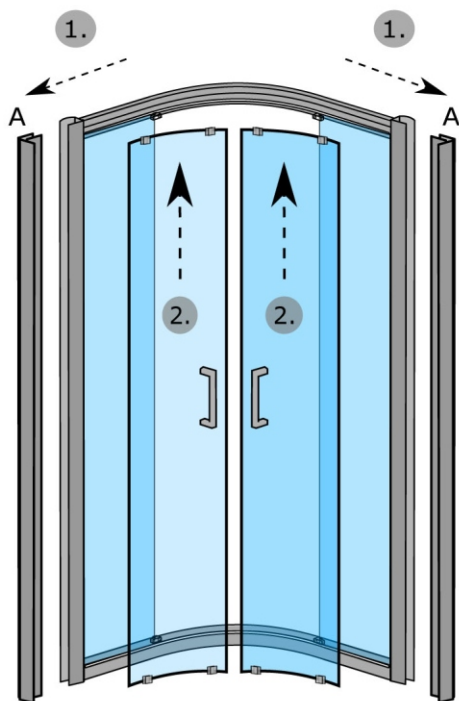
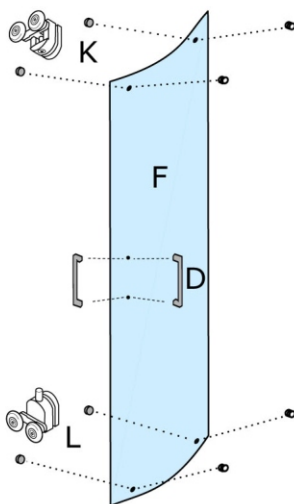
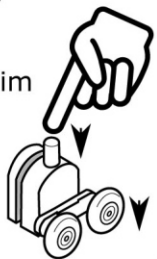

1. Umetanje okvira sa fiksnim staklima u već pričvršćene zidne profile (A).

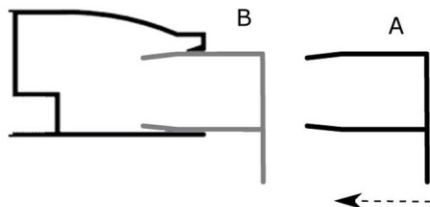

2.

Umetanje vrata u vodilice.

Vrata se prvo okače na gornju vodilicu (gornji točkići se ubacuju na mjestu gdje je vodilica proširena), te pritiskom "dugmića" na donjim točkićima ubace u donju vodilicu.

## 2 Sastavni dijelovi - lista

A

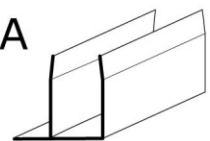

Profil zidni  
x2

B

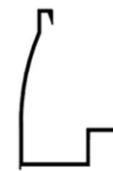

Profil za staklo  
x2

C



Gornja-zatvorena  
vodilica

D



Donja-otvorena  
vodilica

E



Staklo fiksno  
x2

F

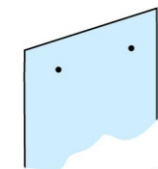

Vrata  
(6 rupa)  
x2

G

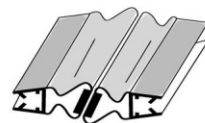

Brtve-magnetne

H

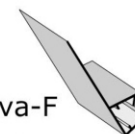

Brtva-F  
x4

I



Brtva za fiksno staklo  
x2

J



Rukohvat  
x2

K

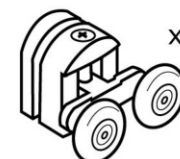

Točkić gornji  
x4

L



Točkić donji  
x4

M



Gumeni stoper  
x8

N

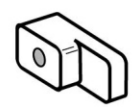

Držać fiksnog stakla  
x4

### 3 Nivelacija i učvršćivanje zidnih profila

Libelom izvršiti nivelaciju zidnih profila.

Označite mjesto za bušenje na zidu.

Obratiti pažnju na to da se dimenzija kabine broji od krajnje ivice zidnog profila.

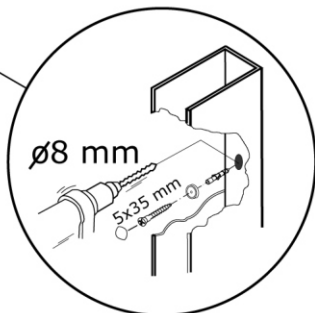
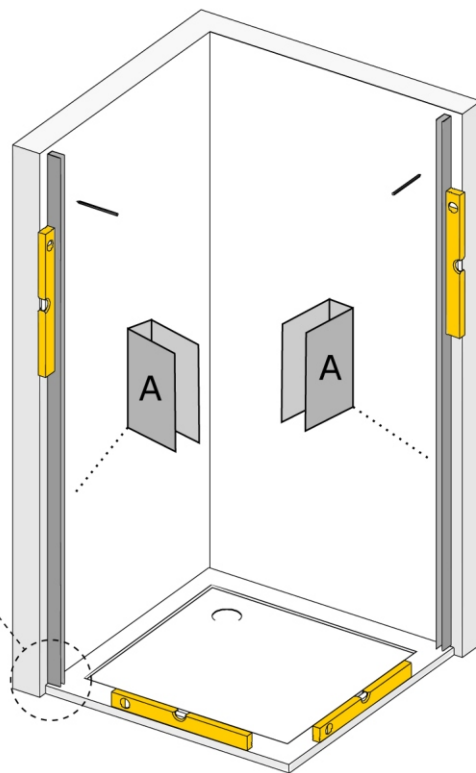
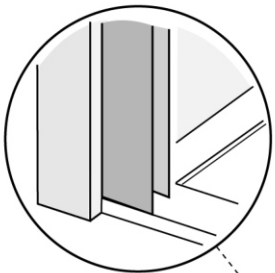

Odmaknite profil, izbušite rupe i postavite tiplove.

Nanesite silikon na zadnju stranu profila, postavite profil na zid i pričvrstite ga vijcima 5x35 mm.

3

www.hidrastil.ba

### 4 Montaža fiksnih stakala i vodilica

Spajanje gornje vodilice (C) sa vertikalnim profilom (B) pomoću vijaka 3,5x25/38. Ukrasna rozeta (O) se postavlja na samom spoju.

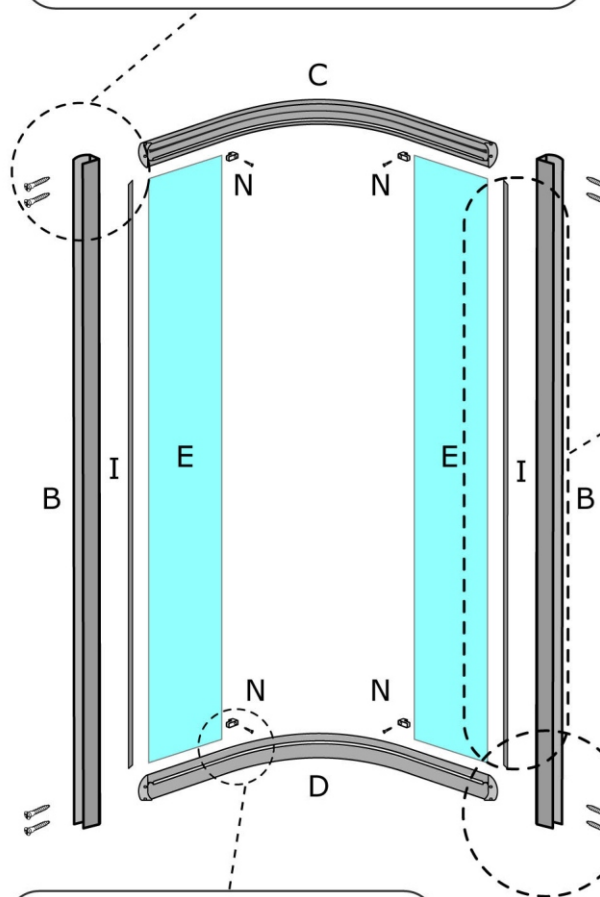

Fiksiranje držača fiksnih stakala (N) vijcima 4,2x13 upuštene glave.

Spajanje donje vodilice (D) sa vertikalnim profilom (B) pomoću vijaka 3,5x25/38. Ukrasna rozeta (O) se postavlja na samom spoju.

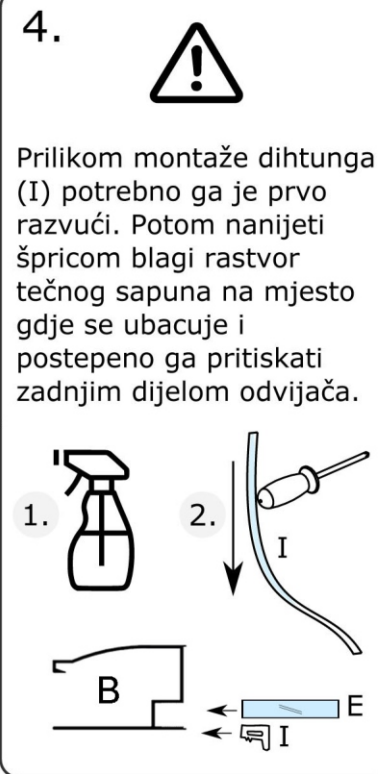

www.hidrastil.ba

4