

MODEL: CLARUS 2V+2F  
(sk.13 i 14 u katalogu)

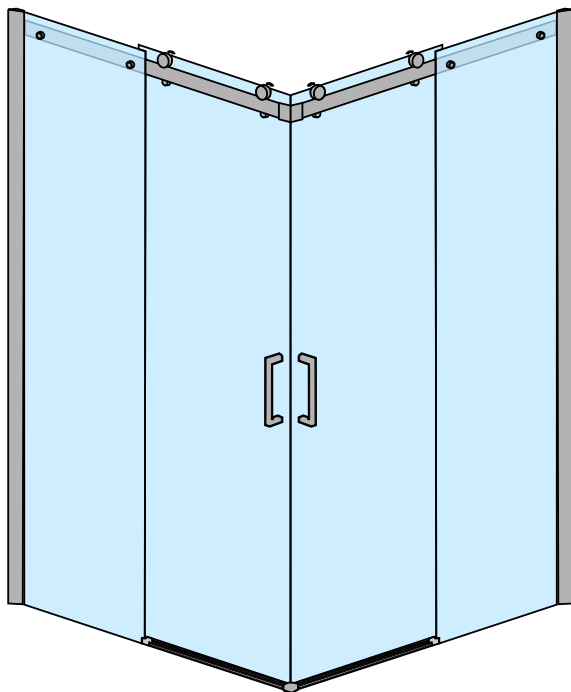

### MODELI

80x80 H200

90x90 H200

100x100 H200

100x80 H200

...

Iako je kvalitet materijala za kabine vrhunske kvalitete, može biti oštećen kako mehanički, tako i upotrebom određenih hemikalija (acetona i sl.). Takođe je moguće narušiti sjaj profila upotrebom abrazivnih sredstava.

U procesu ugradnje kabine preporučujemo da tuš, ako se na isti vrši montaža, zaštitite kartonom od mogućih oštećenja pri montaži kabine.

Proizvođač ne odgovara za štetu ili povredu osoba nastalih nepravilnom ugradnjom.



# 1 Sastavni dijelovi - šema

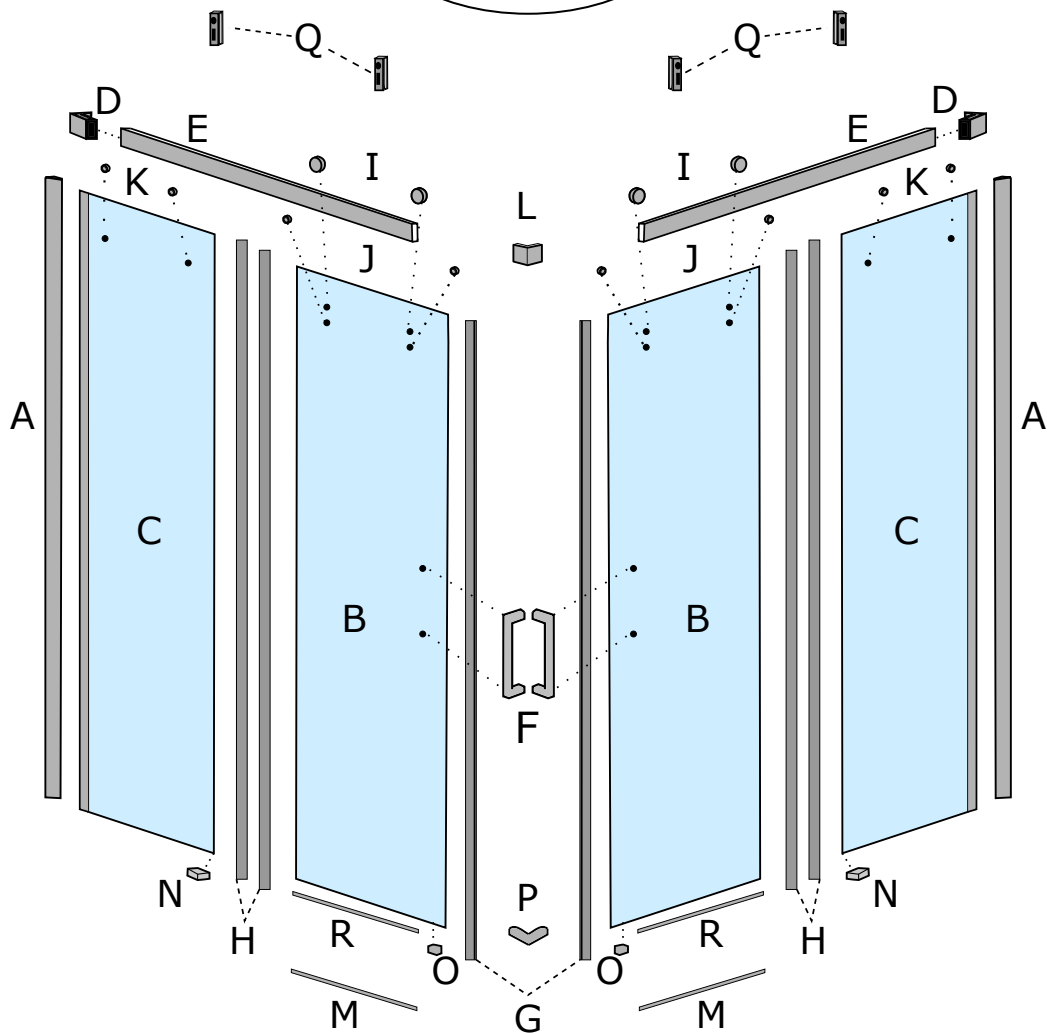
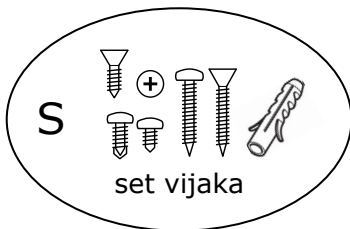

## 2 Sastavni dijelovi - lista



Profil zidni  
x2

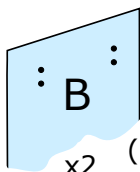

Vrata  
x2 (6 rupa)

Staklo fiksno  
(2 rupe)

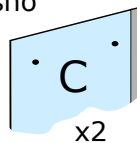

x2

D



x2

Nosač vodilice

x2

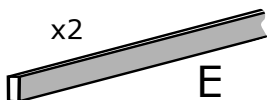

E

Vodilica

Rukohvat

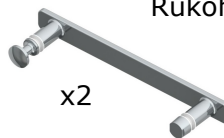

x2

F

G

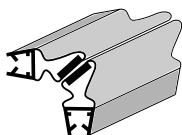

Brtve-magnetne

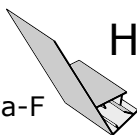

Brtva-F  
x4

I

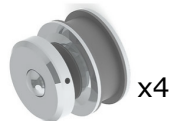

x4

Točkići-nosači stakla

J



x4

Element za zaštitu  
spadanja stakla

K



x4

Element za spajanje  
fiksno stakla na vodilicu

L



Spojnik vodilica

M

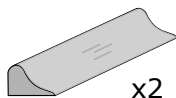

x2

Prag

N



x2

Fiksator-vodilica vrata

O



x2

Točkić-pomoćni za vrata

P



Spojnik pragova

Q

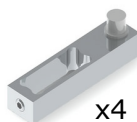

x4

Stoper

R

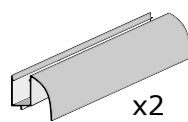

x2

Brtva-okapnica

### 3 Nivelacija i učvršćivanje zidnih profila

Libelom izvršiti nivelaciju zidnih profila.  
Označite mjesto za bušenje na zidu.

Obratiti pažnju na to da se dimenzija kabine broji od krajnje ivice zidnog profila.

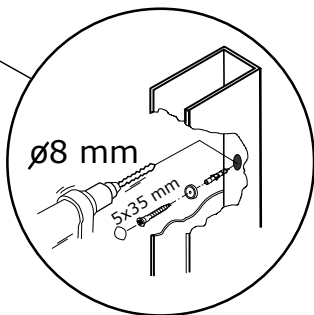
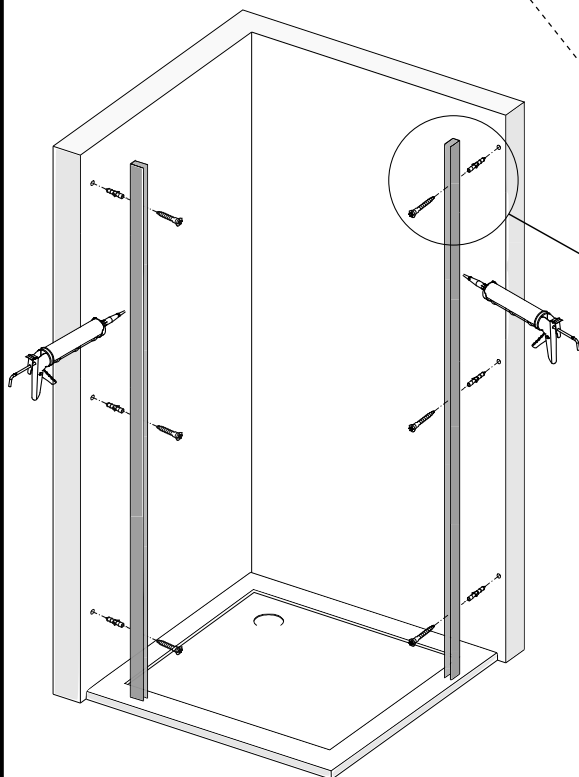
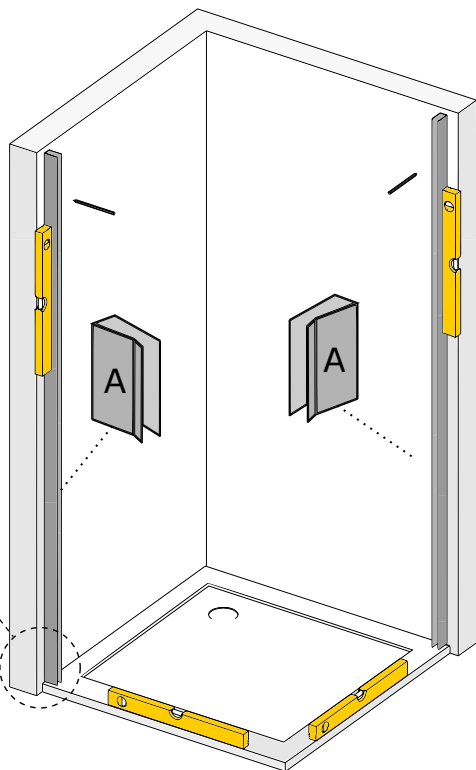
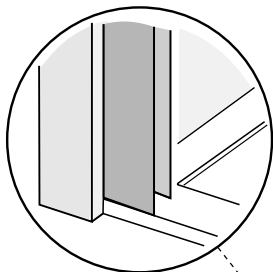

Odmaknite profil, izbušite rupe i postavite tiplove.

Nanesite silikon na zadnju stranu profila, postavite profil na zid i pričvrstite ga vijcima 5x35 mm.

## 4 Montaža fiksnih stakala i vodilice

Na vodilice (E) s obje strane staviti stopere (Q) tako da gledaju jedan prema drugom, te zidne fiksatore (D) za vodilice.

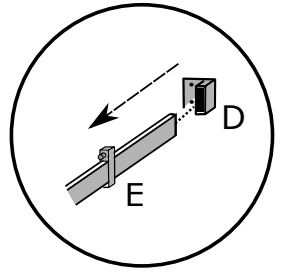
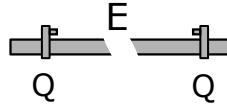

Stoper koji se nalazi na strani bliže zidu može biti pozicioniran ispred ili iza fiksatora stakla, zavisno od dimenzije kabine.



Vodilice pričvrstiti za fixna stakla (C) elementima K, potom fixna stakla umetnuti u zidne profile.

Elementi K su ekscentrični, te se preporučuje da se podese tako da nosač-vodilica bude u krajnjoj gornjoj poziciji.

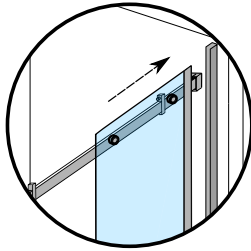
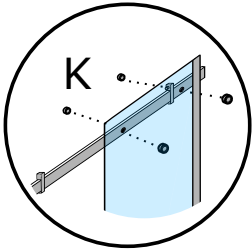

Na zidu označiti mjesto za bušenje, te ponovo ukloniti stakla i izbušiti rupe za fiksatore vodilica.

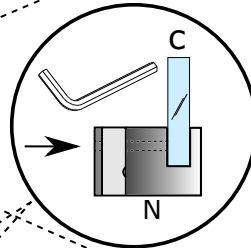
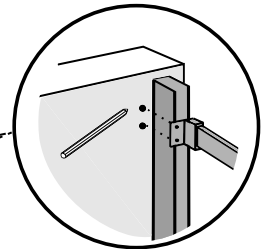
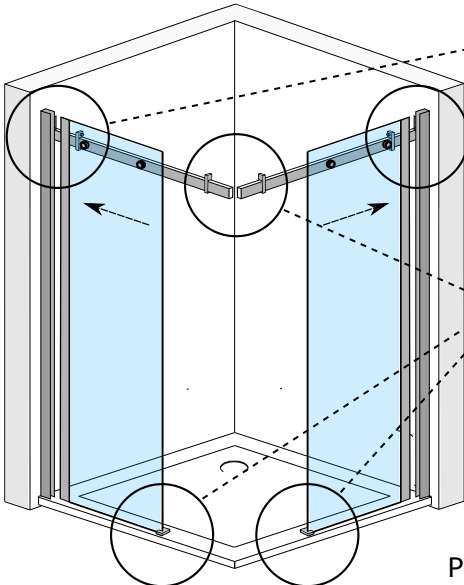

Na donjem uglu fiksnog stakla pričvrstiti elemente N za fixna stakla (C), te ih dotegnuti pomoću imbus ključa.

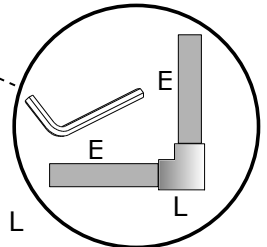

Pričvrstiti ugaoni veznik L za vodilice (E).

## 5 Montaža vrata

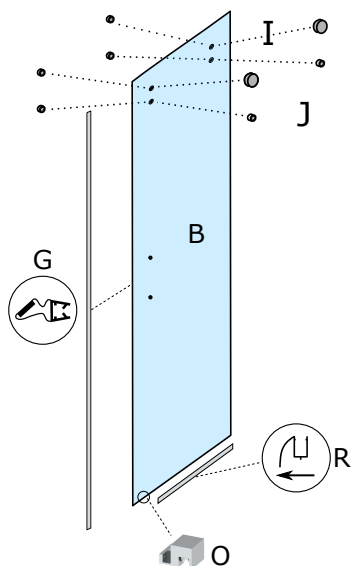

Na vrata (B) zavrnuti velike noseće točkove (I) te pričvrstiti elemente J.

Elementi I i J su ekscentrični, te ih ne treba dotezati do kraja radi finih podešavanja i nivelacije vrata.

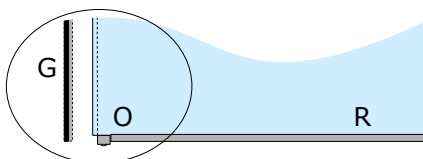

Postaviti pomoćni točkić (O) kako je prikazano na crtežu, ostavljajući dovoljno mjesta za ravnu magnetnu brtvu (G).

Postaviti brtvu okapnicu (R), pazeći da je peraje okrenuto prema unutrašnjosti kabine, kako je i prikazano.

Postaviti vrata na vodilicu i iznivelisati pomoću ekscentričnih točkova (I), zatim optimalno postaviti elemente J te ih na kraju sve dotegnuti imbusom.

Pomjeriti stopere (Q) na optimalnu poziciju i takođe ih dotegnuti.

Montirati rukohvat F.

Stoperi koji se nalaze na strani bliže zidu mogu biti pozicionirani ispred ili iza fiksatora stakla, zavisno od dimenzije kabine.

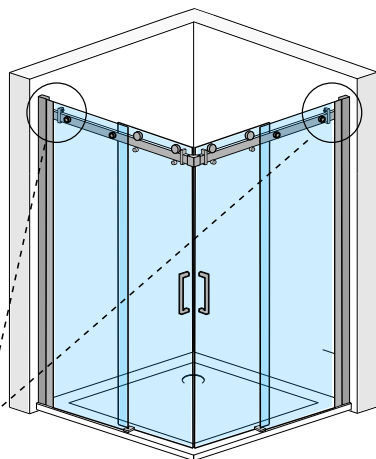

## 6 Završni radovi

Postaviti pragove (M) u proreze na fiksatorima-vodilicama (N), te fspojnik pragova (P).

Odmjeriti odgovarajuću dužinu pragova te ih po potrebi skratiti.

Nakon što smo na donju stranu pragova nanijeli silikon, ponovo ih umetnuti u fiksator N, te postaviti spojnik P.

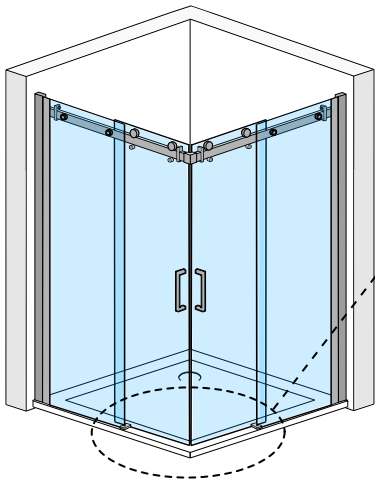
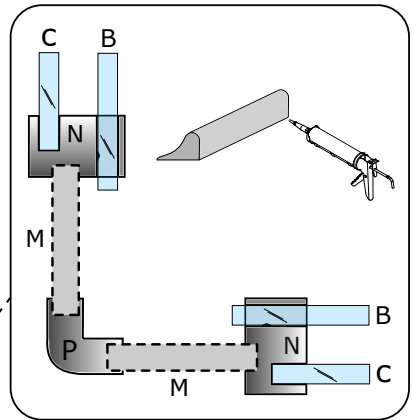

Postaviti F-brtve (H) kako je prikazano na skici.

Postaviti magnetne brtve (G) kako je prikazano na skici.

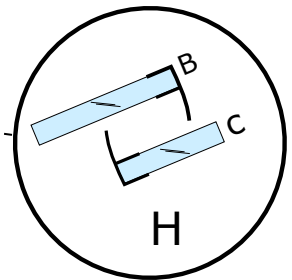
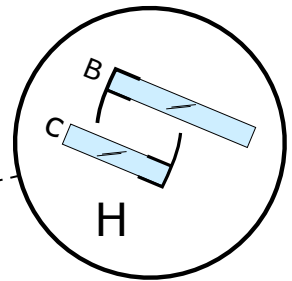
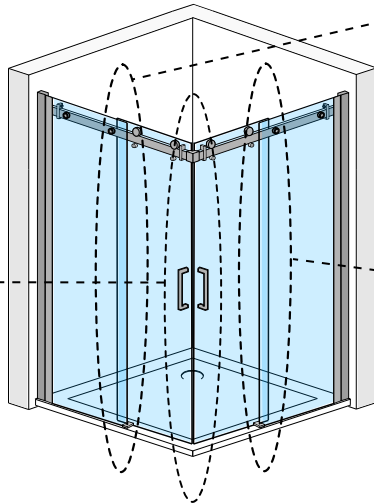
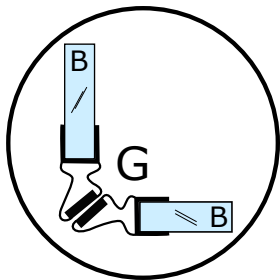

## 6 Završni radovi

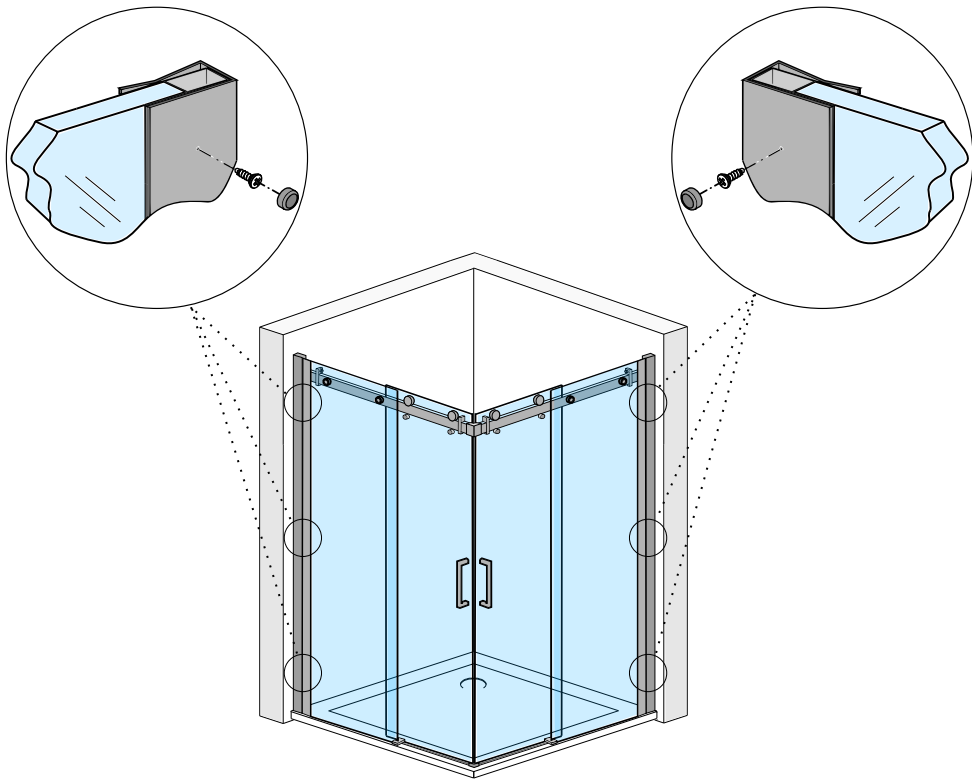

Nakon što su vrata iznivelesana, svi vezni elementi dotegnuti, potrebno je još pričvrstiti kabinu za zidne profile samoreznim vijcima 4,2x13.

**Poslije montaže kabine  
sačekati 24 h prije prve  
upotrebe.**



24 h

