

MODELI

80x80 H200

90x90 H200

100x100 H200

100x80 H200

...

Iako je kvalitet materijala za kabine vrhunske kvalitete, može biti oštećen kako mehanički, tako i upotrebom određenih hemikalija (acetona i sl.). Takođe je moguće narušiti sjaj profila upotrebom abrazivnih sredstava.

U procesu ugradnje kabine preporučujemo da tuš, ako se na isti vrši montaža, zaštitite kartonom od mogućih oštećenja pri montaži kabine.

Proizvođač ne odgovara za štetu ili povredu osoba nastalih nepravilnom ugradnjom.



1 Sastavni dijelovi - šema

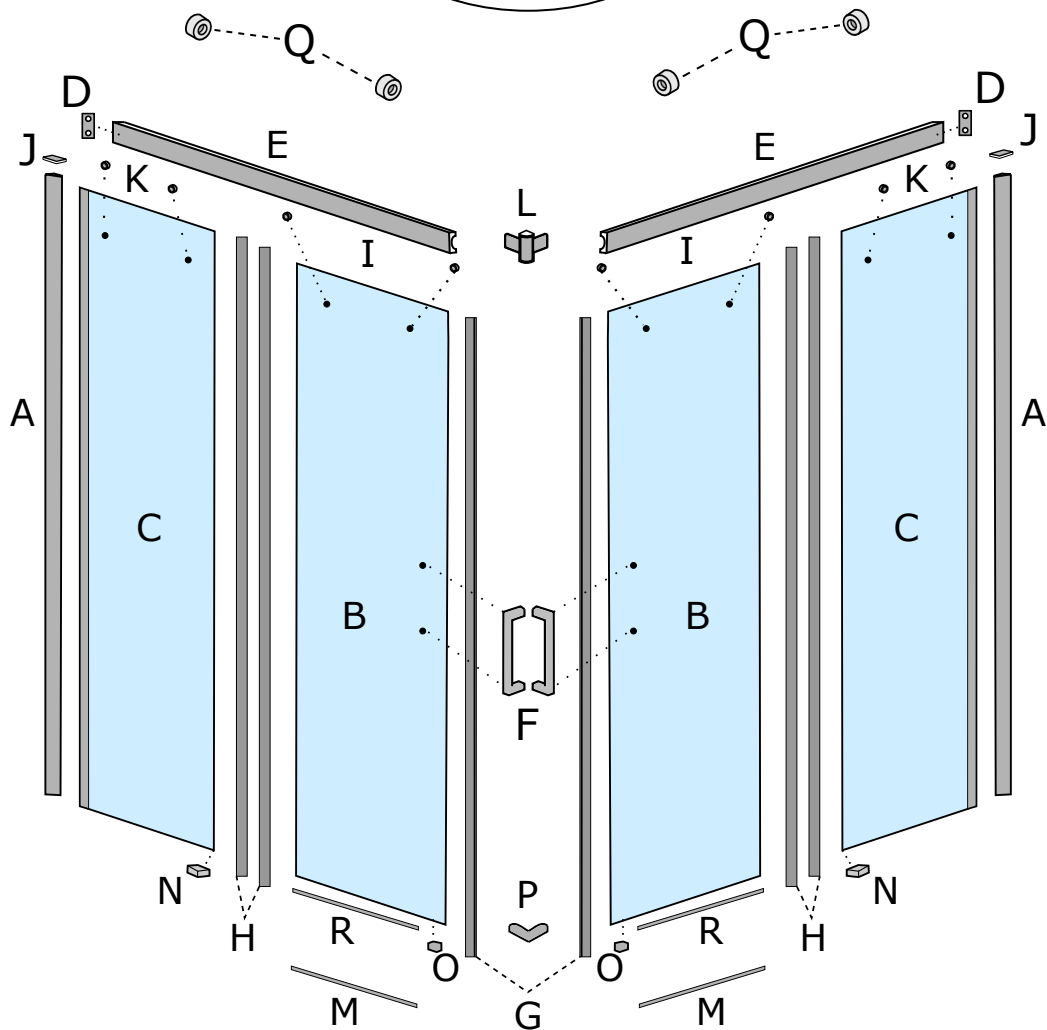
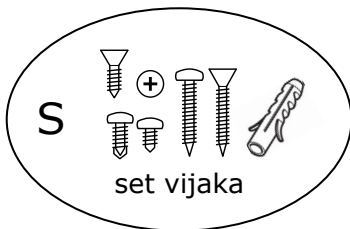

2 Sastavni dijelovi - lista

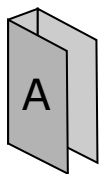

A Profil zidni
x2

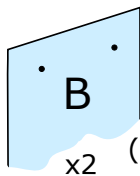

B Vrata
x2 (4 rupe)

Staklo fiksno

(2 rupe)
x2

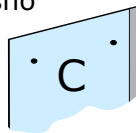

C

D

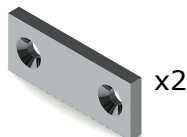

Zatvarač vodilica

x2

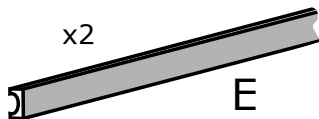

Vodilica

E

Rukohvat

x2

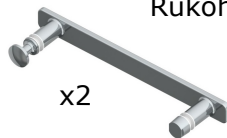

F

G

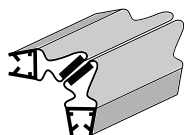

Brtve-magnetne

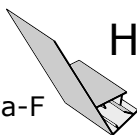

Brtva-F
x4

H

I



x4

Točkići-nosači vrata

J

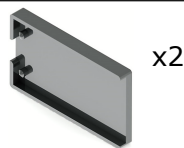

x2

Čep za vertikalni
profil

K



x4

Element za spajanje
fiksno stakla na vodilicu

L



Spojnik vodilica

M

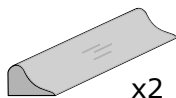

x2

Prag

N



x2

Fiksator-vodilica vrata

O

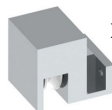

x2

Točkić-pomoćni za vrata

P



Spojnik pragova

Q

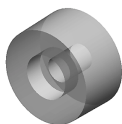

x4

Stoper

R

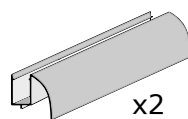

x2

Brtva-okapnica

3 Nivelacija i učvršćivanje zidnih profila

Libelom izvršiti nivelaciju zidnih profila.

Označite mjesto za bušenje na zidu.

Obratiti pažnju na to da se dimenzija kabine broji od krajnje ivice zidnog profila.

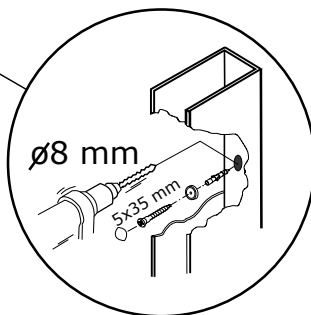
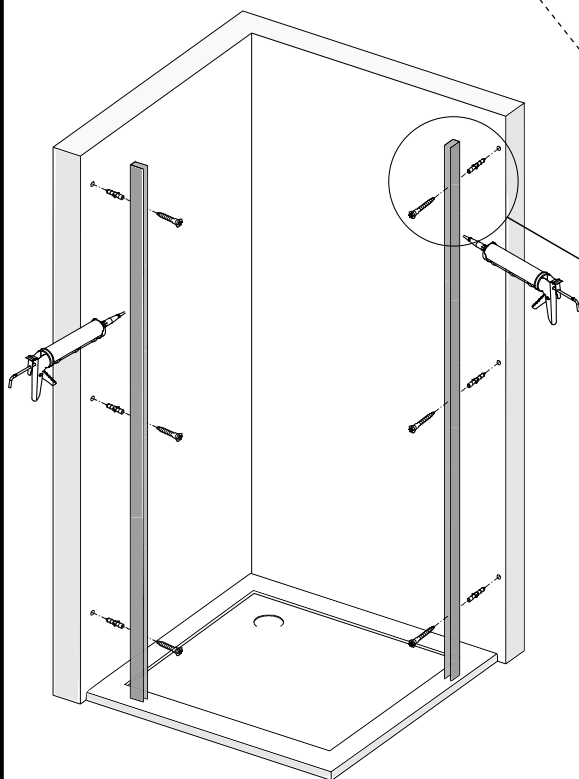
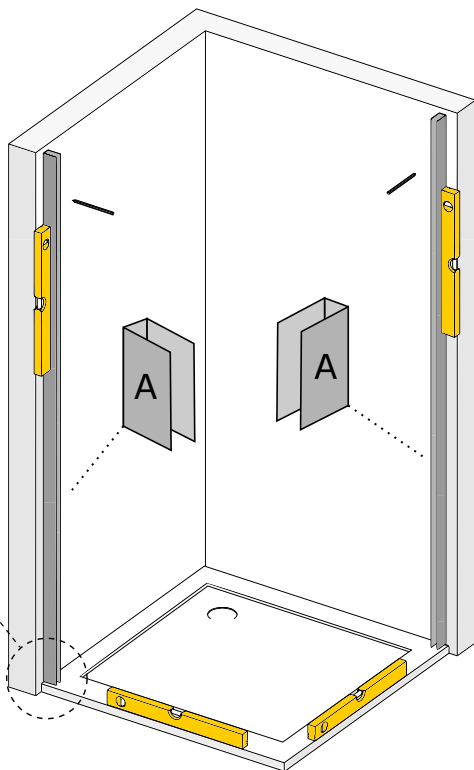
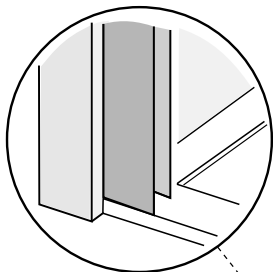

Odmaknite profil, izbušite rupe i postavite pločve.

Nanesite silikon na zadnju stranu profila, postavite profil na zid i pričvrstite ga vijcima 5x35 mm.

4 Montaža fiksnih stakala i vodilice

Na vodilice (E) zavrnuti zatvarače vodilice (F) na strani gdje su bliže rupe za stakla, kako je prikazano na skici.

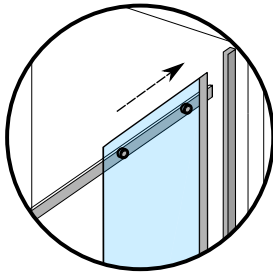
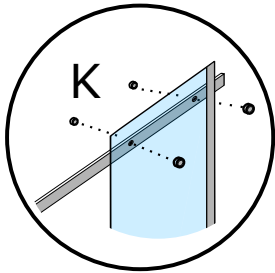
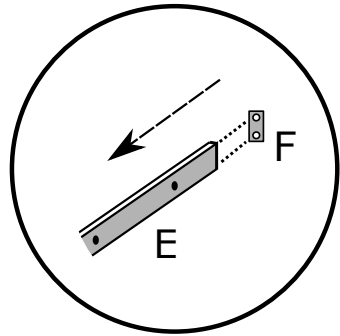

Vodilice pričvrstiti za fiksna stakla (C) elementima (K), potom fiksna stakla uklopiti sa zidnim profilima.

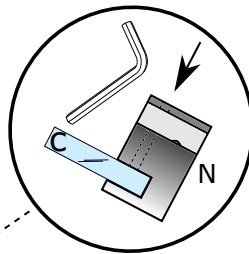
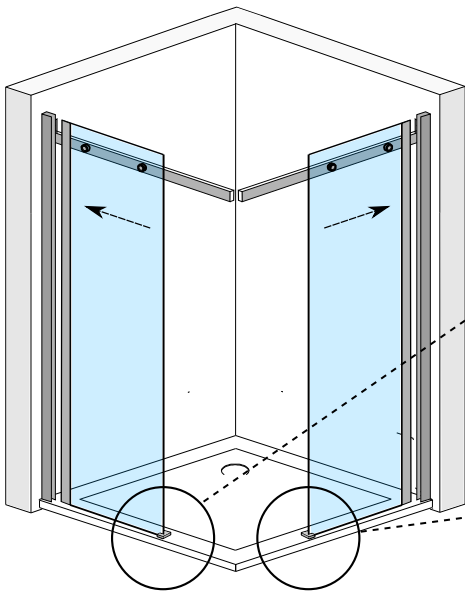

Na donjem uglu fiksnih stakla pričvrstiti elemente N za fiksna stakla (C), te ih dotegnuti pomoću imbus ključa.

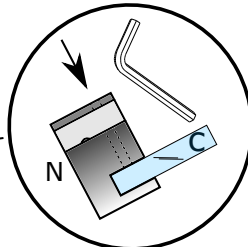

5 Montaža vrata

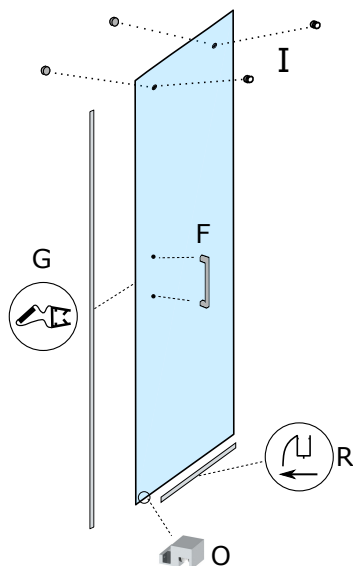

Na vrata zavrnuti velike noseće točkiće (I).

Točkići (I) su ekscentrični, te ih ne treba dotezati do kraja radi finih podešavanja i nivelacije vrata.

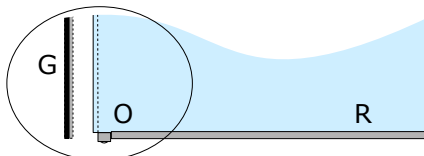

Postaviti pomoćni točkić (O) kako je prikazano na crtežu, ostavljajući dovoljno mjesta za ravnu magnetnu brtvu (G).

Postaviti brtvu okapnicu (R), pazeći da je peraje okrenuto prema unutrašnjosti kabine, kako je i prikazano.

Montirati rukohvat (F).

Ubaciti vrata u vodilice i iznivelisati pomoću ekscentričnih točkova (I).

Ubaciti ugaoni veznik L u vodilice (E), te ga pričvrstiti samoreznim vijcima.

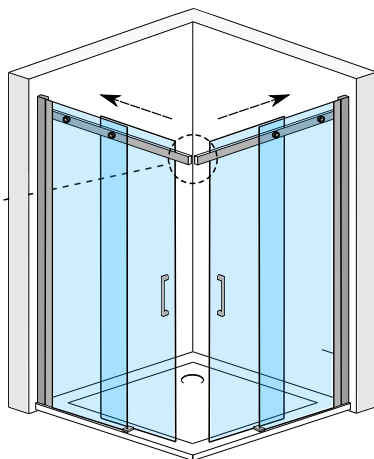
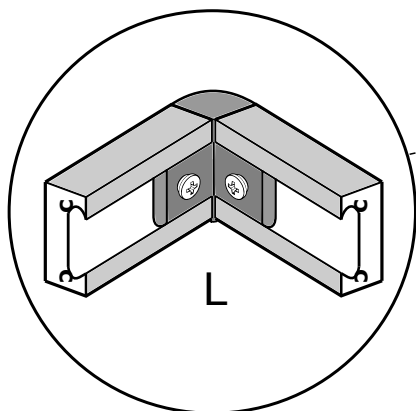

6 Završni radovi

Nakon što smo vrata i fiksna stakla iznivelisali, pričvrstiti fiksna stakla za zidne profile samoreznim vijcima 4,2x13.

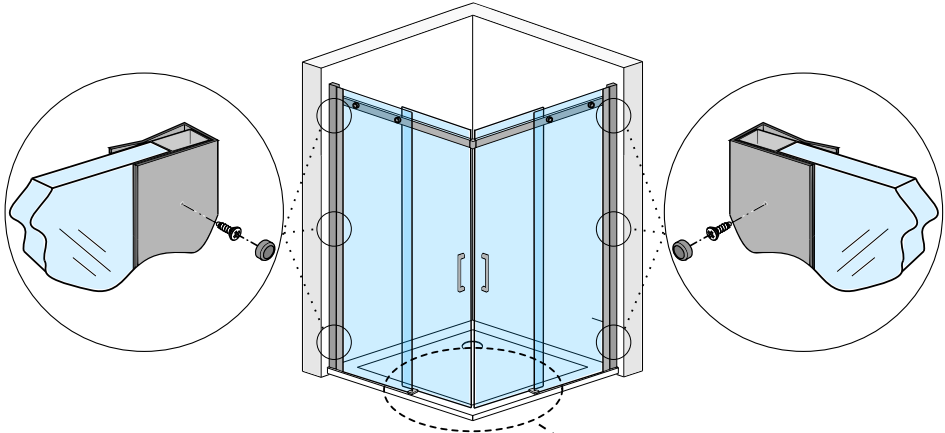

Postaviti pragove (M) u proreze na fiksatorima-vodilicama (N), te spojnik pragova (P).

Odmjeriti odgovarajuću dužinu pragova te ih po potrebi skratiti.

Nakon što smo na donju stranu pragova nanijeli silikon, ponovo in umetnuti u fiksator N, te postaviti spojnik P.

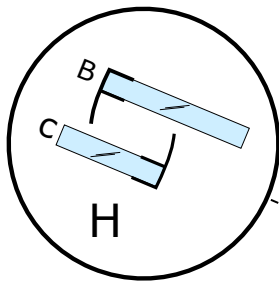
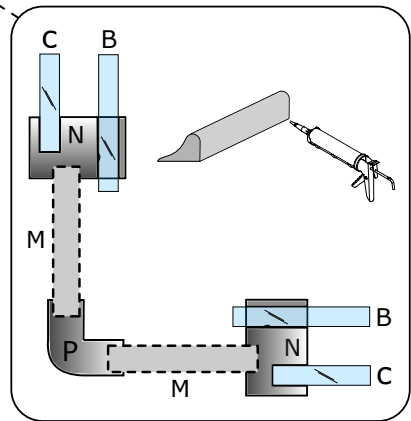

Postaviti F-brtve (H) kako je prikazano na skici.

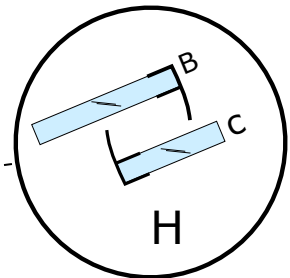
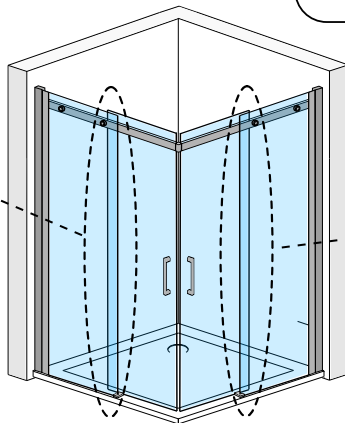

6 Završni radovi

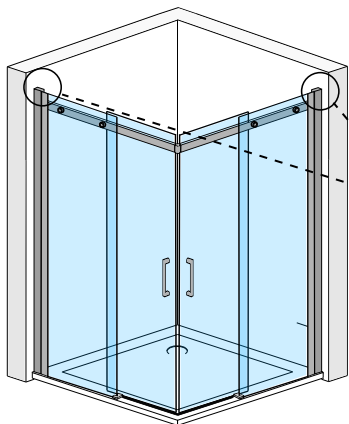

Nakon što su se odredile idealne pozicije za zaustavljanje vrata, zavrnuti stopere (Q) unutar vodilice.

Na kraju je ostalo još da se postave poklopci (J) na vertikalne profile.

