

Uputstvo za montažu polukružnih kabina

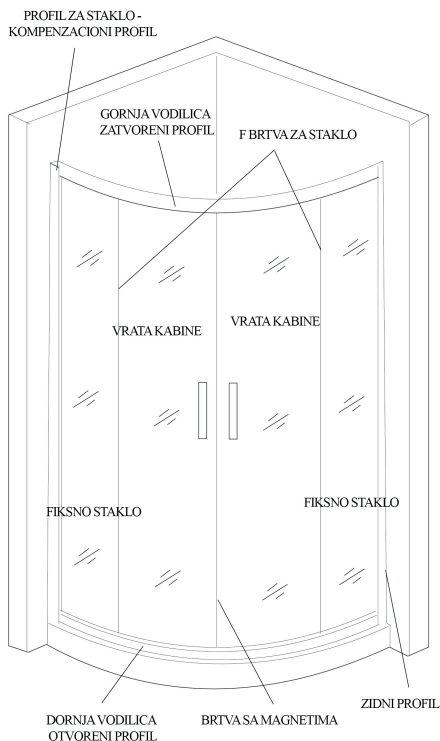

MODEL: OPAL

DIMENZIJE:

80x80 H183
90x90 H183
100x100 H183
80x80 H160
90x90 H160
100x100 H160



Iako je kvalitet materija za kabine vrhunske kvalitete, može biti oštećen kako mehanički tako i upotrebom određenih hemikalija (ačeton i sl.). Takođe je moguće narušiti sjaj profila upotrebom abrazivnih sredstava.

U procesu ugradnje kabine preporučujemo da tuš, ako se na isti vrši montaža, zaštitite kartonom od mogućih oštećenja pri montaži kabine.







Proizvađač ne odgovara za štetu ili povredu osoba nastalih nepravilnom ugradnjom.

Kabinu/paravan treba da montiraju dvije osobe.

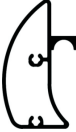
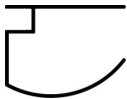



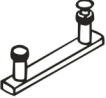





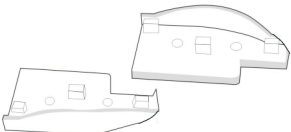

Brčko, BiH, tel. 049 590 470, fax. 049 590 473

POPIS ELEMENTA

OZNAKA	NAZIV ELEMENTA	IZGLED ELEMENTA	KOLIČINA
A	Vodilica gornja - zatvoren profil		1
B	Vodilica donja - otvoren profil		1
C	Profil za staklo - kompenzacioni profil		2
D	Zidni profil		2
E	Tockic gornji		4
F	Tockic donji		4
G	Rukohvat / Rucka		2
H	Brtva sa magnetima		1

POPIS ELEMENTA

OZNAKA	NAZIV ELEMENTA	IZGLED ELEMENTA	KOLIČINA
H	F brtva za staklo -visina 2 m		4
I	Brtva: profil - staklo		2
J	Bocni element - rozetna na spoju vodilice i vertikalnog profila		2 lijeva + 2 desna
K	Držac fiksnog stakla + Vijak 4,2x16, upuštena glava		4 + 4
L	Vijak 3,5x25/32 - za spajanje vodilica sa vertikalnim profi.		8
M	Vijak 4,2x13, samourezujući ravna glava		6
N	Vijak 5x35, za tipl		6
O	Vijak 4,2x9,5 mm, za stoper ravna glava		8
P	Tipl Ø8 mm, Fischer		6
R	Granicnik/Stoper, gumeni		8

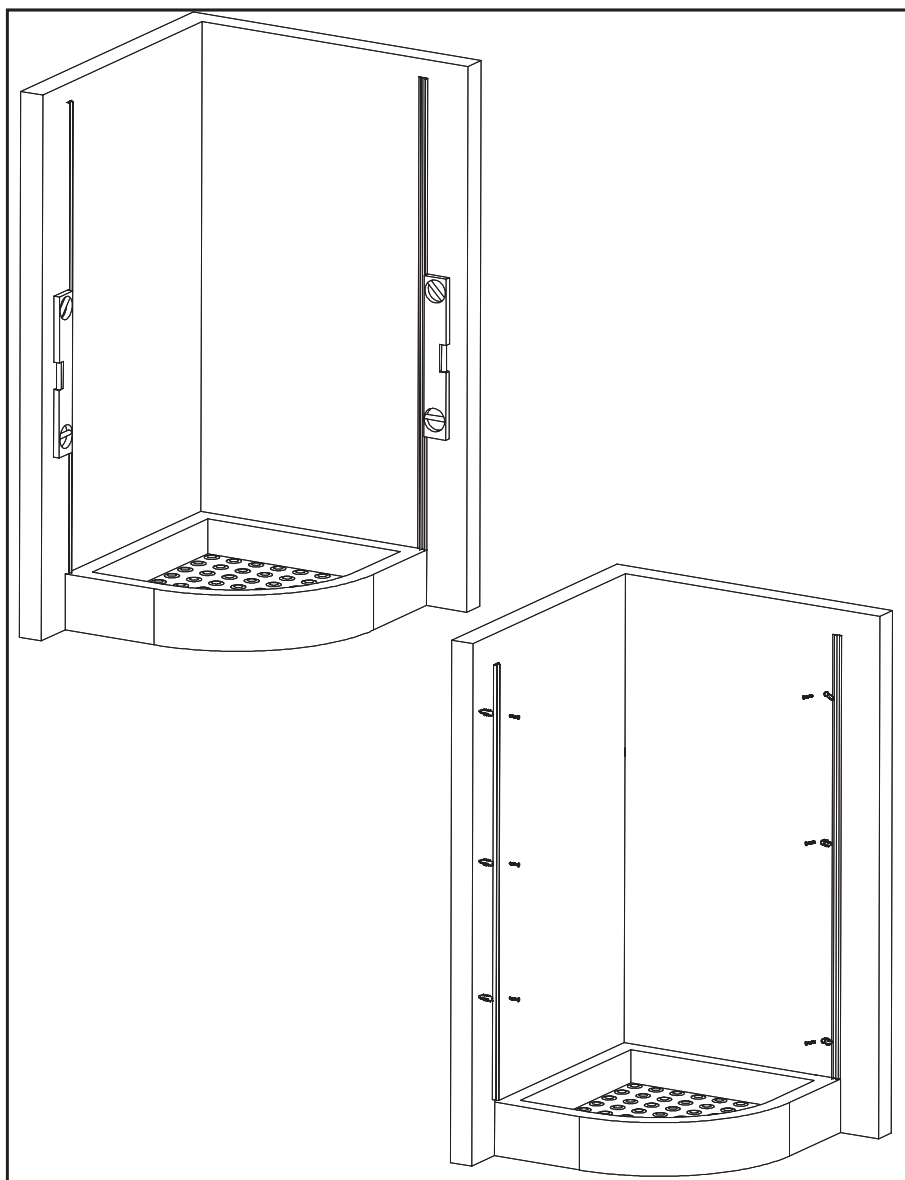

Profil za zid postaviti na zid iznad kade , nivelirati i olovkom označiti mjesto gdje će se montirati profil .
Izbušiti rupe na zidu i montirati profil za zid .

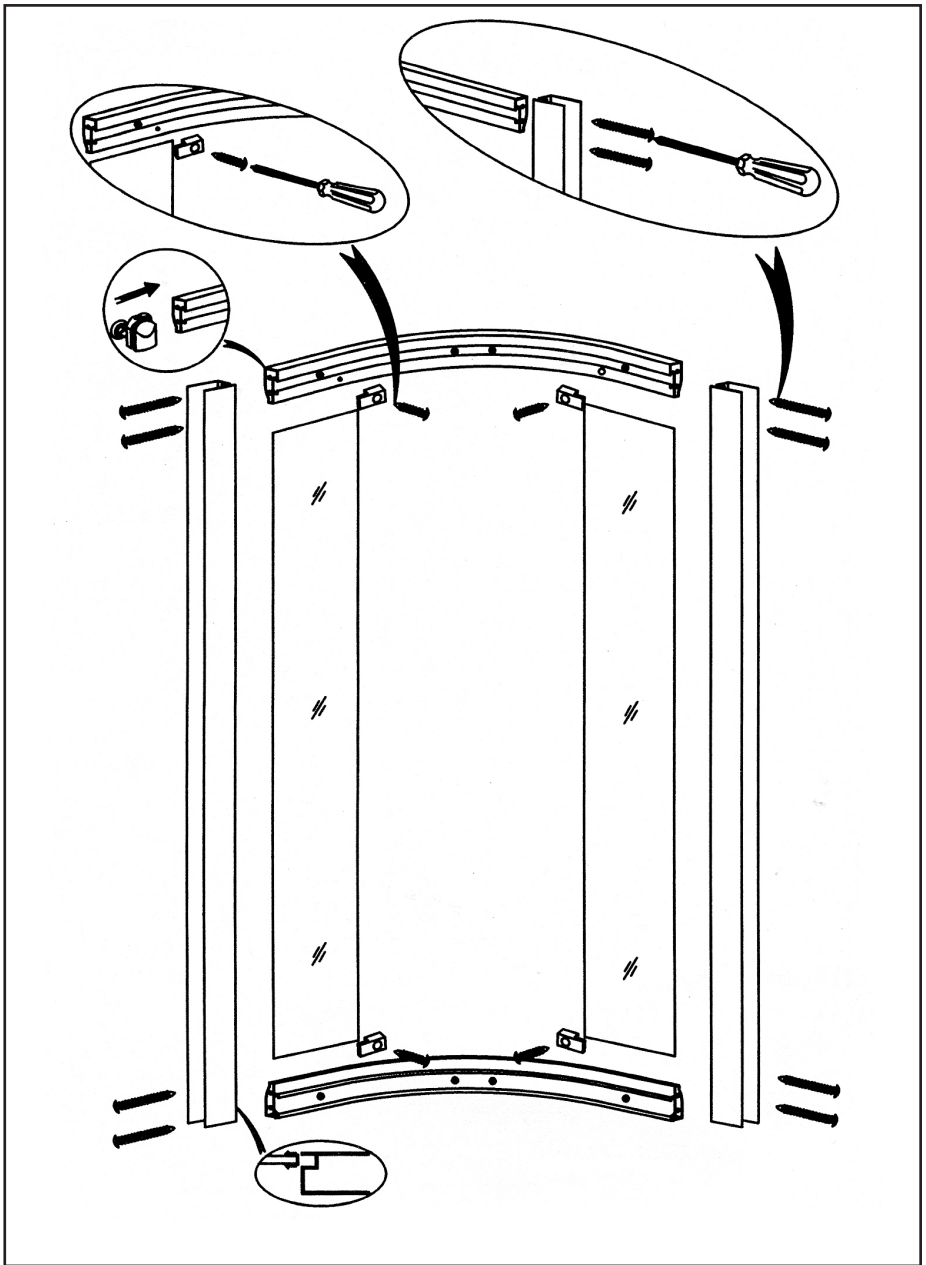

Kabinu montirati kao što je prikazano na slici .

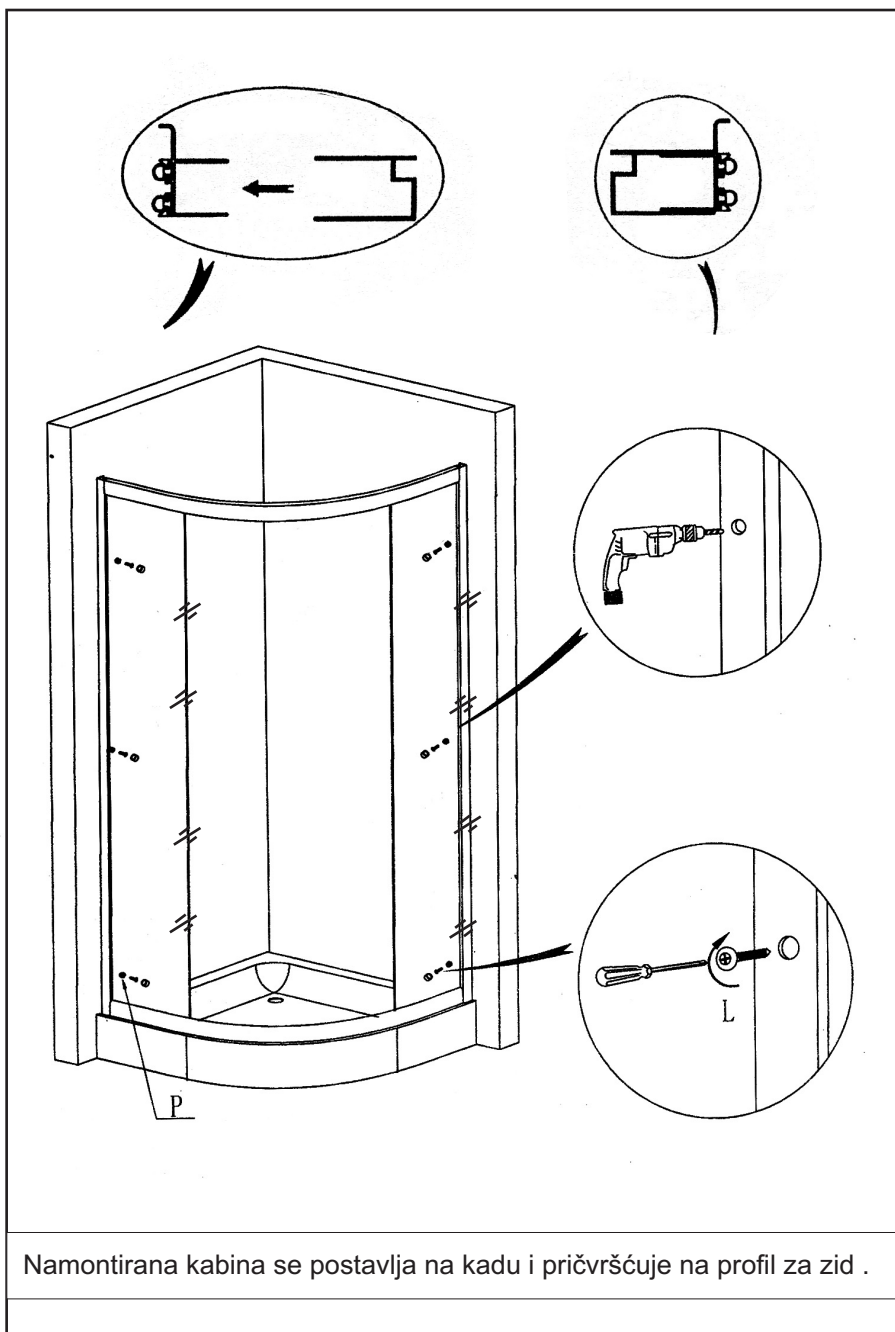

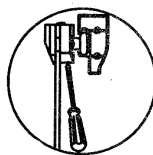
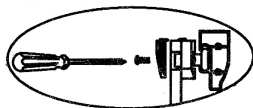

Nakon ugradnje
kabinu ne koristiti
24 h kako bi silikon
dobro dihtovao

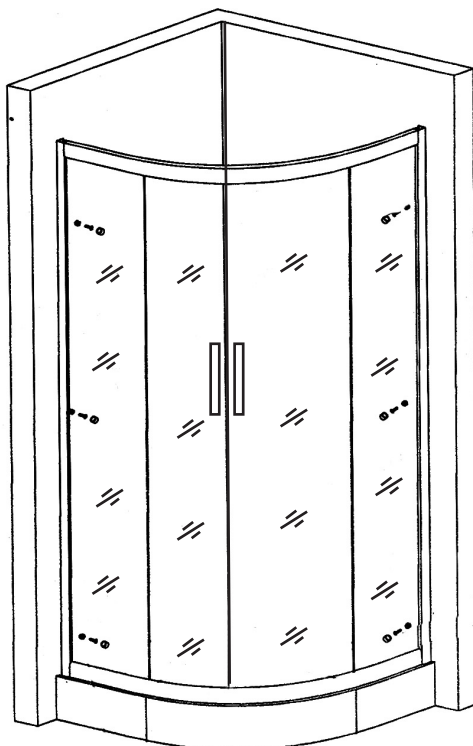

Na zakrivljena stakla se montiraju točkići i staklo se postavlja na odgovarajuće profile kao što je prikazano na slici

Vijak za podešavanje gornjeg točka

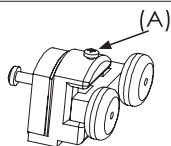

Ako se vrata dobro ne zatvaraju
podešavanje se vrši koristeći vijak (A)

Magnetni keder

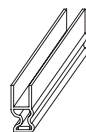

F Keder za staklo

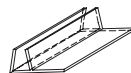

F brtva se postavlja na stakla tako da
pera budu okrenuta jedna prema drugom.

Između profila i stakla ubačuje se brtva.
Zbog lakšeg ubačivanja brtve potrebno je istu
rastezati pri ugradnji, obzirom da je od silikona.

